

 Deutsche  
 Qualität  
 Garantiert



108

HALF  
CELLS

182  
mm

CELL  
SIZE



LID  
RESISTANT



PID  
RESISTANT



SALT CORROSION  
RESISTANT



SAND  
RESISTANT



AMMONIA  
RESISTANT



HIGHLY STABLE  
AND TOUGH

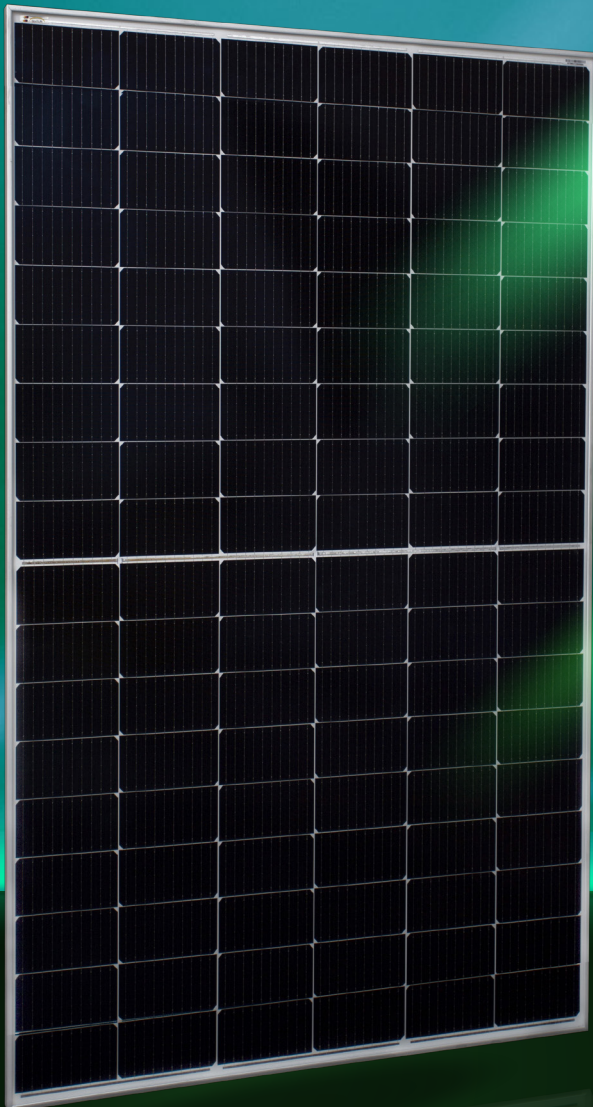

# AURORA

**HIGH** ENERGY YIELD  
RELIABILITY  
DURABILITY

30

years

Performance  
Guarantee

15

years

Product  
Warranty

MONO-CRYSTALLINE PV MODULES  
HALF-CUT CELLS • MONO-FACIAL

**395W-415W**  
AE MD-108 Series



IEC 61215  
IEC 61730  
Regular Production Surveillance  
Type Tested and Monitored

IEC 62716 (Ammonia corrosion)  
IEC 61701 (Salt mist corrosion)  
IEC 60068 (Sand and dust)  
IEC 62804 (PID resistance)

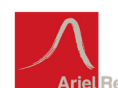

www.ae-solar.com

### Mechanical and design specification

Cell type	Gallium-doped Mono c-Si PERC, Half-cut cells, 182 mm
No. of cells	108
Glass	3.2 mm, high transmission, AR coated, tempered
Encapsulation	EVA
Back cover	White backsheet
Junction box	IP 68 rated
Frame	35 mm anodized Aluminium alloy
Cable	1 x 4 mm <sup>2</sup> , 350 mm length or customized
Connectors	MC 4 / MC 4 compatible
Dimension	1724 mm x 1133 mm x 35 mm
Weight	21.5 kg
Hail resistance	Max. Ø 25 mm at 23 m/s
Wind load	2400 Pa/ 244 kg/ m <sup>2</sup>
Mechanical load	5400 Pa/ 550 kg/ m <sup>2</sup>

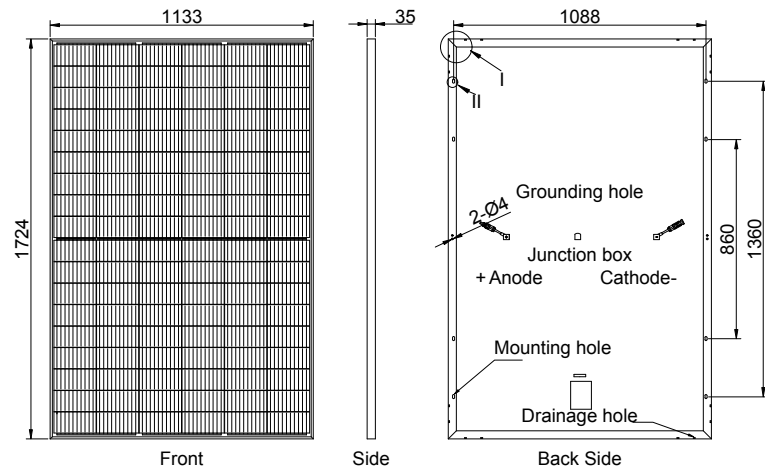

### Packaging information

Packaging configuration	62 pcs / double pallet
Loading capacity	806 pcs / 40 HQ
Size / Pallet	1755 mm x 1140 mm x 2490 mm
Weight	1432 kg / double pallets

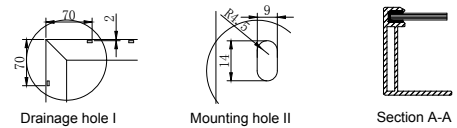

### Temperature ratings

Operating temperature	(°C)	-40 to +85
Temp. coefficient of P <sub>max</sub>	(%/°C)	-0.35
Temp. coefficient of V <sub>oc</sub>	(%/°C)	-0.275
Temp. coefficient of I <sub>sc</sub>	(%/°C)	0.045
Nom. operating temp. NOCT	(°C)	45 ± 2

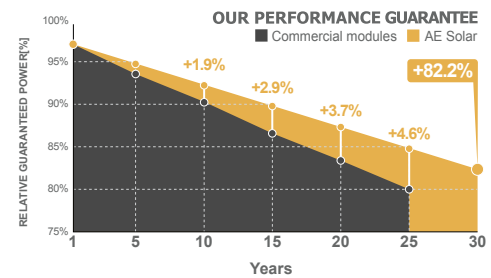
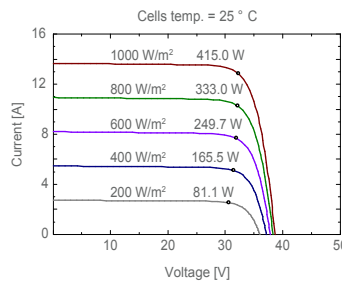

Electrical specifications (STC*):		AE395MD-108	AE400MD-108	AE405MD-108	AE410MD-108	AE415MD-108
Nominal Max. Power	P <sub>max</sub> (Wp)	395	400	405	410	415
Maximum operating voltage	V <sub>MPP</sub> (V)	31.08	31.35	31.62	31.88	32.12
Maximum operating current	I <sub>MPP</sub> (A)	12.71	12.76	12.81	12.86	12.92
Open-circuit voltage	V <sub>oc</sub> (V)	37.36	37.69	38.02	38.35	38.67
Short-circuit current	I <sub>sc</sub> (A)	13.47	13.52	13.57	13.62	13.67
Module efficiency	η (%)	20.22	20.48	20.73	20.99	21.25
Power tolerance	(W)			0~+5		
Maximum system Voltage	(V)			1500		
Maximum series fuse rating	(A)			25		

\*STC: Standard test conditions (Irradiance 1000 W/m<sup>2</sup>, Cell temperature 25°C and air mass of AM1.5)

Electrical specifications (NMOT*):		AE395MD-108	AE400MD-108	AE405MD-108	AE410MD-108	AE415MD-108
Nominal Max. Power	P <sub>max</sub> (Wp)	298	301	304	308	311
Maximum operating voltage	V <sub>MPP</sub> (V)	29.30	29.50	29.70	29.90	30.10
Maximum operating current	I <sub>MPP</sub> (A)	10.17	10.21	10.25	10.29	10.34
Open-circuit voltage	V <sub>oc</sub> (V)	35.20	35.40	35.60	35.80	36.00
Short-circuit current	I <sub>sc</sub> (A)	10.78	10.82	10.86	10.90	10.94

\*NMOT: Normal Module Operating Temperature (Irradiance 800 W/m<sup>2</sup>, Ambient temperature 20°C, air mass of AM1.5 and wind speed of 1 m/s)

The specifications and characteristics contained in this datasheet may deviate slightly from our actual products due to the product developments and uncertainty of measurement devices. The specifications included in the datasheet are subject to change without prior notice.

